



LEGACY
POWER CONVERSION



User's Manual

Lineage LI3000 UPS

K01-1120005-00

TABLE OF CONTENTS

SAFETY WARNINGS	3
BLOCK DIAGRAM	4
INSTALLATION	4
- UNPACKING.....	4
- HOW TO DETERMINE THE POWER REQUIREMENTS OF YOUR EQUIPMENT.....	4
- TO ESTIMATE POWER REQUIREMENTS.....	5
- HARDWARE INSTALLATION.....	5
BASIC OPERATION	8
-FRONT PANEL DESCRIPTION.....	8
-REAR PANEL DESCRIPTION.....	9
TROUBLESHOOTING	12
TECHNICAL SPECIFICATION	13
DEFINITIONS FOR ILLUMINATED LED INDICATORS	14
BATTERY REPLACEMENT	15
LIMITED WARRANTY	16

SAFETY WARNINGS

- This manual contains important safety instructions. Please read and follow all instructions carefully during installation and operation of the unit. Read this manual thoroughly before attempting to unpack, install, or operate.
- The AC power outlet must be installed near the UPS and must be easily accessible.
- Attention, risk of electric shock. Disconnecting this unit from the power mains, does not remove the risk. Voltage may still be present from the battery pack. The battery pack quick connectors should be disconnected before performing maintenance or service work on the UPS.
- When replacing the batteries, use the same number and type of batteries
- Do not open or mutilate the battery or batteries. Electrolyte is harmful to the skin and eyes.
- A battery can present a risk of electric shock and high short circuit current. The following precaution should be observed when working on batteries
 - Remove watches, rings or other metal objects.
 - Use tools with insulated handles.
 - Never short circuit the battery terminals.

BLOCK DIAGRAM

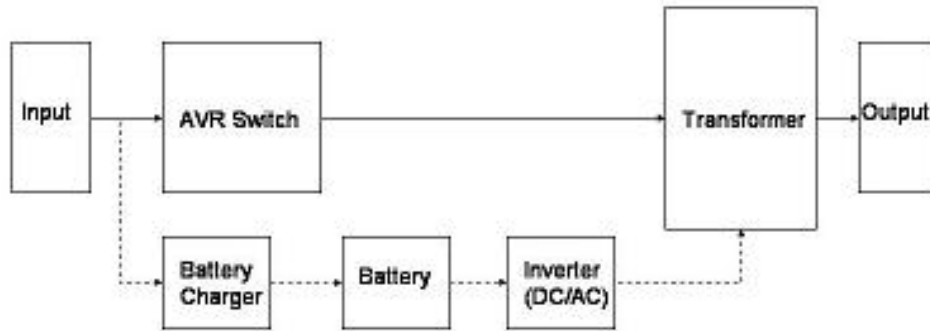

INSTALLATION

UNPACKING

Inspect the UPS upon receipt. The box of LI3000 should contain the following:
(1) UPS Unit; (1) User's Manual; (2) Rack Mount Brackets; (2) Stands; (1) SeeUPS2020 Software Disk; (1) Telephone Cable; (2) Serial Interface Cables (RS232); (1) Serial-to-USB cable

HOW TO DETERMINE THE POWER REQUIREMENTS OF YOUR EQUIPMENT

1. Insure that the equipment plugged into the seven battery power-supplied outlets does not exceed the UPS unit's rated capacity (3000VA/2200W for LI3000). If rated unit capacities are exceeded, an overload condition may occur and cause the UPS unit to shut down or the circuit breaker to trip.
2. If the power requirements of your equipment are listed in units other than Volt-Amps (VA), convert Watts (W) or Amps (A) into VA by doing the calculations below. Note: The below equation only calculates the maximum amount of VA that the equipment can use, not what is typically used by the equipment at any one time.

Users should expect usage requirements to be approximately 60% of the maximum value.

TO ESTIMATE POWER REQUIREMENTS:

1. _____ Watts (W) x 2.0 = _____ VA or _____ Amps (A) x 120 = _____ VA

2. Add the totals up for all pieces of equipment and multiply this total by 0.6 to calculate actual requirements. There are many factors that can affect the amount of power that your computer system will require. The total load that you will be placing on the battery-powered outlets should not exceed 80% of the unit's capacity.

HARDWARE INSTALLATION

1. Your new UPS may be used immediately upon receipt. However, recharging the battery for at least **four** hours is recommended to insure that the batteries are fully charged. Charge loss may occur during shipping and storage. To recharge the battery, simply leave the unit plugged into an AC outlet. The unit will charge in both the on as well as the off position.

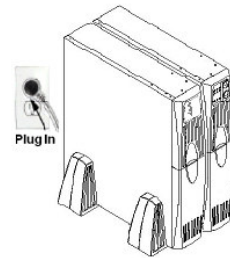

2. If you wish to use the software, connect the enclosed serial interface cable to the serial port on the UPS and an open serial port on the computer. If you would like to use USB interface, please connect the USB adapter with the serial cable then connect the USB adapter to your computer.

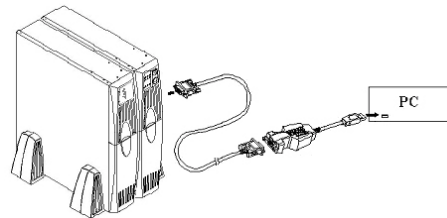

3. With the UPS unit off and unplugged, connect your computer, monitor, and any other devices into the battery power supplied outlets. **DO NOT** plug a laser printer, copier, space heater, vacuum, paper shredder or other

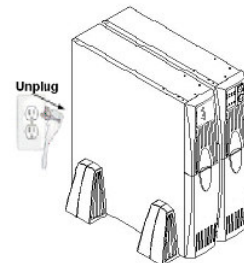

large electrical device into the UPS. The power demands of these devices will overload and possibly damage the unit.

4. To surge protect a network connection, connect a network cable from the wall jack outlet to the IN jack of the UPS. Then connect a network cable from the OUT jack on the UPS to the network device.
5. Plug the UPS into a wall outlet. Make sure the wall branch outlet is protected by a fuse or circuit breaker and does not service equipment with large electrical demands (e.g. refrigerator, copier, etc...). Avoid using extension cords. If used, the extension cord must be rated for 30 Amps.
6. Depress the power switch to turn the unit on. The power on indicator light will illuminate.
7. Your UPS is equipped with an auto-charge feature. When the UPS is plugged into an AC outlet, the battery will automatically recharge.
8. To maintain optimal battery charge, leave the UPS plugged into an AC outlet at all times.
9. To store your UPS for an extended period, cover it and store with the battery fully charged. Recharge the batteries every three months to insure battery life.
10. To connect auxiliary battery pack :
 - (a.) Remove the protection cover on the UPS rear panel.
 - (b.) Connect the **black wire and the red wire of the Battery Pack** to the **negative (-) / black terminal and the positive (+) / red terminal of the PR3000** respectively. (See Figure 1)

****Note:** Due to the large current, make sure to connect the positive to positive and the negative to negative. Otherwise, it may cause a short circuit and the unit may be irreversibly damaged.

Figure 1: Connecting LI3000 with Battery Pack

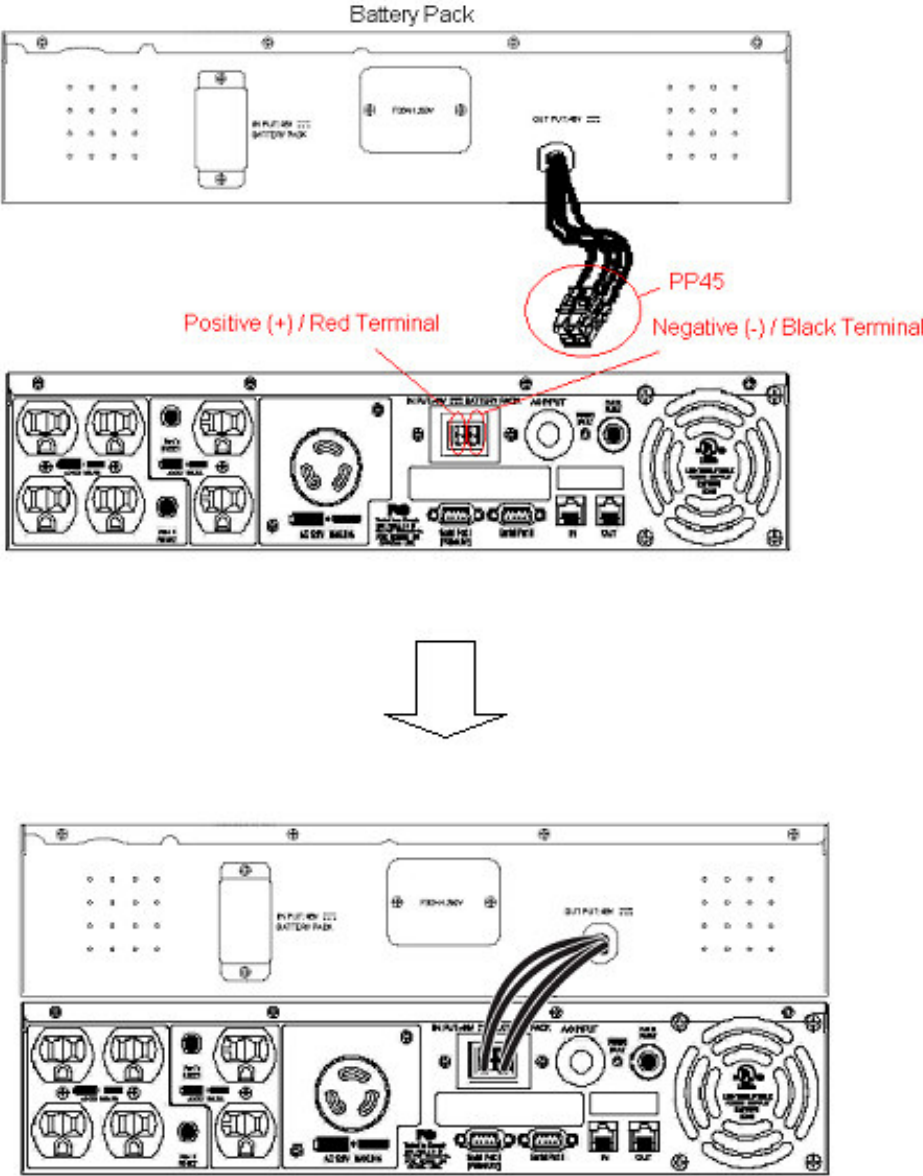

BASIC OPERATION

FRONT PANEL DESCRIPTION

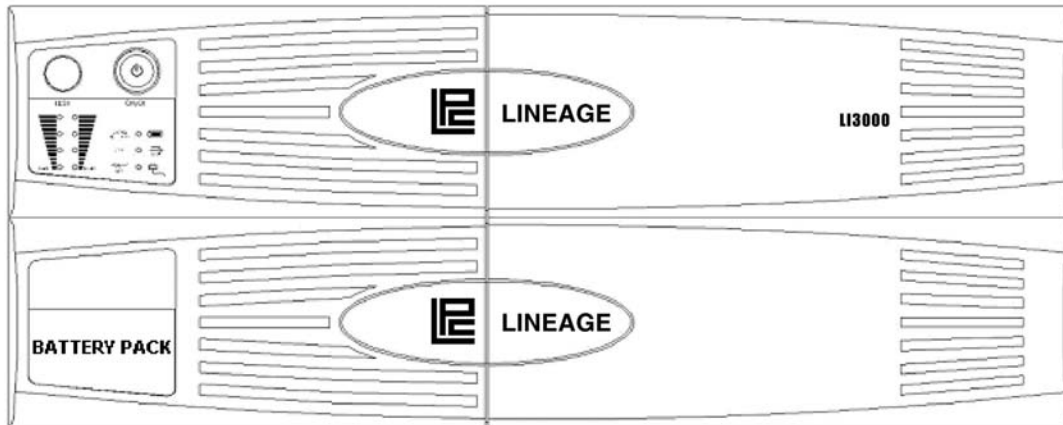

◆ Power Switch



Press the power button to turn the UPS ON or OFF

◆ Test Switch



The LI3000 UPS performs a self-test automatically on power on. If the UPS passes the test, it returns to on-line operation. If the UPS fails the self-test, please recharge the battery for 4 hours and perform another self-test. If it fails after recharging the battery, please replace the battery.

◆ Battery Indicators



This indicator shows a visual indication of the battery charge. If battery capacity is under 20%, no indicator LED will illuminate and UPS starts beeping.

◆ Load Level Indicators



This indicator shows a visual depiction of the UPS load. The load indicator LED will turn orange if the load is between 80 and 100%. If the load is under 20%, no indicator LED will illuminate.

◆ Power On Indicator



This LED is illuminated when the utility condition is normal and the UPS outlets are providing “clean power”, free of surges and spikes

◆ Battery Indicator



This illuminates during utility failure, indicating that the battery is supplying power to the battery-power supplied outlets.

◆ AVR Indicator



This LED indicates that the UPS is operating in automatic voltage regulation mode. When the led is illuminated continuously, it indicates input over-voltage and the UPS unit bucks the voltage. When the led is flashed in rotation, it indicates that the UPS unit is boosting input voltage.

REAR PANEL DESCRIPTION

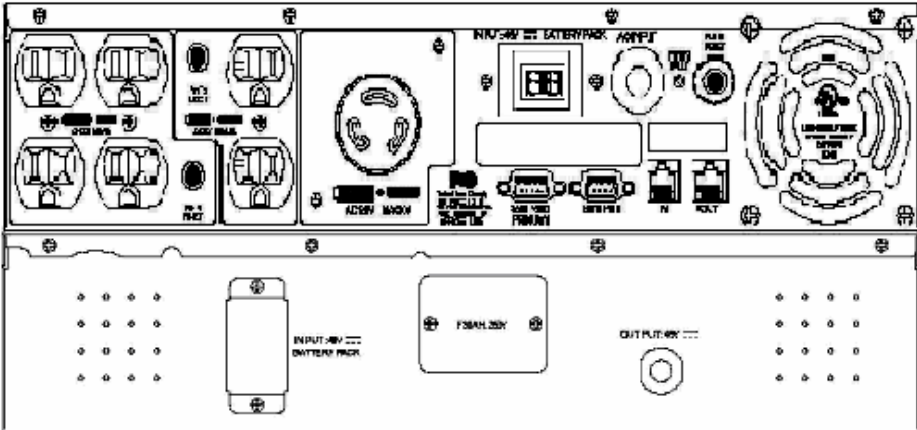

◆ Circuit Breaker Reset for Overload Protection



Re-settable circuit breakers provide optimal overload protection.

◆ Battery Backup and Surge Protection Outlets

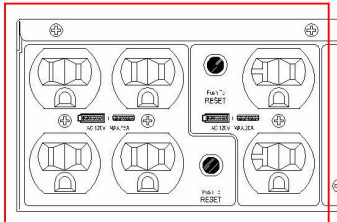

Provides six battery powered, surge protected and AVR outlets for connected equipment and insures uninterrupted operation of connected equipment during a power failure.

◆ Individual Backup Power for Critical Load

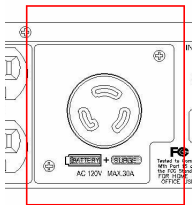

Provides a battery powered, surge protected and AVR outlet for the most critical connected equipment and insures uninterrupted operation of connected equipment during a power failure.

** NOTE: When the UPS is overloaded, the other six minor outlets will not provide power to equipments, prior to the Individual Backup Power Outlet.

◆ Communication Protection Ports

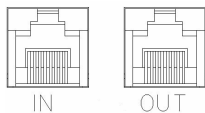

Ethernet RJ-45 Network Protection Ports protect standard network cables.

◆ Dual Serial Ports

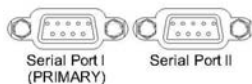

The LI3000 provides two serial ports to allow connection and communication between the UPS and two computers. (See Figure 2) This allows the simultaneous shutdown of two computer systems. These interfaces are also compatible with the UPS service provided by Windows 2000, Windows,

Windows NT, Windows XP, Windows Server 2003 and Mac OS 10X.

The Primary computer (with SeeUPS2020 Plus installed) is the computer that you will use to control the UPS and make any change to the operation of the UPS. The Secondary computer (with SeeUPS2020 installed) is unable to exhibit any control over the UPS.

When power failure occurs, one of the following shutdown sequences will be executed:

1. If the Primary and Secondary serial ports are both in use: the Primary computer will start to count down (user controlled delay) for shutdown (User Control delay can be set in the SeeUPS2020 Plus software. Recommended time is 5 minutes). Once the Primary computer is shutdown, the UPS will signal the Secondary computer and initiate the Secondary to shutdown. The UPS default shutdown time is 2 minutes. Therefore, it is recommended that Secondary computer is set to shutdown within 1 minute in SeeUPS2020 Software.
2. If only the Secondary serial port is in use: the Secondary computer will shutdown following the user settings in SeeUPS2020 Software. However, the Secondary computer will not be able to signal the UPS to shutdown. Therefore, the UPS will only power off when it is in low battery.

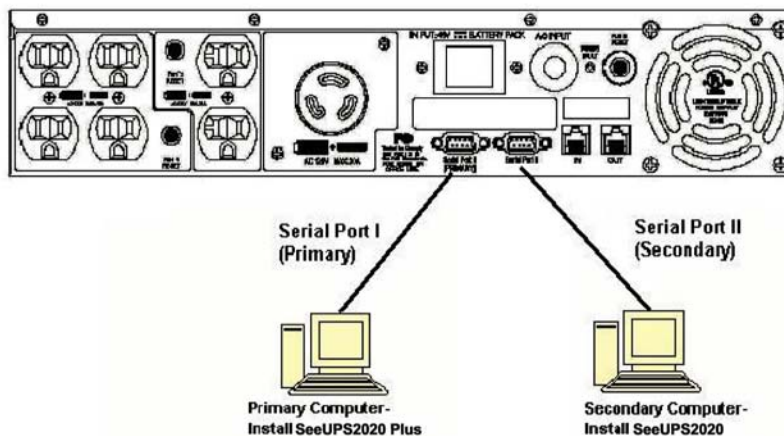

Figure 2: Dual Serial Port and Software Installation





TROUBLESHOOTING

Problem	Possible Cause	Solution
Outlets do not provide power to equipment	Circuit breaker is tripped due to overload.	Turn the UPS off and unplug at least one piece of equipment. Wait 10 seconds, reset the circuit breaker and then turn the UPS on.
	Batteries are discharged.	Recharge the unit for at least 4 hours
	Unit has been damaged by a surge or spike.	Recharge the battery by leaving the UPS plugged in at least 4 hours.
The UPS does not perform expected runtime.	Battery is not fully charged.	Recharge the battery by leaving the UPS plugged in at least 4 hours.
	Battery is slightly worn out.	Contact Legacy Power Conversion about replacement batteries at service@lpc-ups.com or 800-859-5711.
The UPS will not turn on.	The on/off switch is designed to prevent damage by rapidly turning it off and on.	Turn the UPS off. Wait 10 seconds and then turn the UPS on.
	The unit is not connected to an AC outlet.	The unit must be connected to a 110/120V 50/60Hz outlet.
	The battery is worn out.	Contact Legacy Power Conversion about replacement batteries at service@lpc-ups.com or 800-859-5711.
	Only the individual Backup power outlet provides power to equipment.	Press the Self-Test button to recover the other six outlets.
See UPS2020 is inactive (all icons are gray).	The serial cable is not connected.	Connect the serial cable to the UPS unit and an open serial port of your computer. You must use the cable that came with the unit.
	The serial cable is connected to the wrong port.	Try another serial port of your computer
	The unit is not providing battery power.	Shutdown your computer and turn the UPS off. Wait 10 seconds and turn the UPS on. This should reset the unit.
	The serial cable is not the cable that was provided with the unit.	You must use the cable included with the unit for the software.

TECHNICAL SPECIFICATIONS

Model	LI3000
Capacity (VA)	3000VA
Capacity (Watts)	2200W
Input	
Voltage Range	85 – 150Vac
Frequency Range	47 – 63Hz
Output	
On Battery Output Voltage	Pure Sine Wave at 120Vac +/- 5%
On Battery Output Frequency	60 Hz
Transfer Time (Typical)	4ms
Overload Protection	On Utility: Circuit Breaker, On Battery: Internal Current Limiting
Surge Protection and Filtering	
Lightning / Surge Protection	Yes
Internet Ready	Yes
Physical	
Total # of UPS Receptacles	7
Maximum Dimensions	2U Rack * 2
Weight (lbs)	122.5
Battery	
Sealed Maintenance Free Lead Acid Battery	7AHx8
Typical Recharge Time	8 Hours
Warning Diagnostics	
Indicators	Power On, Using Battery, AVR, Load Level, Battery Level
Audible Alarms	On Battery, Low Battery, Overload
Environmental	
Operating Temperature	+ 32°F to 95°F (0°C to 35°C)
Operating Relative Humidity	0 to 95% NON-CONDENSING
Communication	
SeeUPS2020 Software	Windows 98/ME/NT/2000/XP, Mac OS 10.0 or later
Management	
Self-Test	Manual Self-Test
Auto-Charger	Yes
Auto-Restart	Yes
USB	Yes
SNMP / HTTP Network	Optional

DEFINITIONS FOR ILLUMINATED LED INDICATORS

 Power On	 AVR	 Using Battery	 Circuit Breaker	 Alarm	Condition
On	Off	Off	Set	Off	Normal
On	Slow flash	Off	Set	Off	AVR- Max. boost 13% of input voltage for output regulation while input voltage is from 8% to 15% under nominal.
On	Rapid flash	Off	Set	Off	AVR- Max. boost 26% of input voltage for output regulation while input voltage is from 15% to 26% under nominal.
ON	On	Off	Set	Off	AVR- Max. buck 13% of input voltage for output regulation while input voltage is from 8% to 26% over nominal.
Off	Off	On	Set	Two Beeps	Utility Failure- The UPS is providing battery power to the Battery backup outlets.
Off	Off	On	Set	Rapid Beeps	Utility Failure- The UPS is providing battery power. Rapid beeps indicate the battery will run out of charge within a few minutes.
On/Off	On/ Off /Flash	On/Off	Set	Long Beep	Overload- Turn the UPS off and unplug at least one piece of equipment from the UPS. Wait 5 seconds, reset the circuit breaker and restart the UPS.
Off	Off	On	Up	Long Beep	Overload- Turn the UPS off and unplug at least one piece of equipment from the UPS. Wait 5 seconds, reset the circuit breaker and restart the UPS.
Off	Off	Off	Set	Off	Surge Protection Malfunction- Power surge has damaged the unit. Please contact Legacy Power Conversion

BATTERY REPLACEMENT

Contact your dealer or call the number in this manual for information on battery replacement.

Read and follow the IMPORTANT SAFETY INSTRUCTIONS before servicing the battery. **Servicing the battery can only be performed by trained personnel knowledgeable of batteries and their precautions.** Keep unauthorized personnel away from batteries.

CAUTION! Use only the specified type of battery. See your dealer for replacement batteries.

CAUTION! The battery may present the risk of electrical shock. Do not dispose of batteries in a fire, as they may explode. Follow all local ordinances regarding proper disposal of batteries.

CAUTION! Do not open or mutilate the batteries. Release electrolyte is harmful to the skin and eyes and may be toxic.

CAUTION! A battery can present a high risk of short circuit current and electrical shock.

Take the following precautions before replacing the battery:

1. Remove all watches, rings or other metal objects.
2. Only use tools with insulated handles.
3. Do not lay tools or metal parts on top of battery or any terminals.
4. Wear rubber gloves and boots.
5. Determine if the battery is inadvertently grounded. If inadvertently grounded, remove source of ground. **CONTACT WITH GROUNDED BATTERY CAN RESULT IN ELECTRICAL SHOCK!** The likelihood of such shock will be reduced if such grounds are removed during installation and maintenance (applicable to a UPS and a remote battery supply not having a grounded circuit).

REMINDER: Batteries are considered as **HAZARDOUS WASTE** and must be disposed of properly. Contact your local government for more information about proper disposal and recycling of batteries.

STORAGE:

First turn off your UPS and disconnect its power cord from the wall outlet. Disconnect all cables connected to the UPS to avoid battery drain. To store your UPS for an extended period, cover it and store with the battery fully charged. Recharge the battery every three months to insure battery life. If the battery remains uncharged for an extended period of time, it may suffer permanent loss of capacity.

LIMITED WARRANTY

In purchasing the LI3000 in the United States or Canada, the original end user receives a Limited Warranty from Legacy Power Conversion, Inc. (for ease of reading, referred to as "Legacy"). The Limited Warranty is intended to be the original end-user's exclusive rights and remedies.

Limited Warranty. The original end user (referred to as the "Initial Customer") receives an express limited warranty (referred to as the "Limited Warranty") for the LI3000 purchased from Legacy (referred to as the "Product"). The Limited Warranty is for the Product itself. The Limited Warranty is subject to the terms set forth below. Additionally, State or Provincial law may adjust the terms of the Limited Warranty or the State or Province may impose additional obligations, or additional "implied warranties." To the extent necessary to comply with those laws, the terms of the Limited Warranty should be read to adjust to those requirements only to the extent necessary to comply with such local law.

If you are an Initial Customer, you are asked to read the following terms and conditions carefully before using the Product. By using the Product you consent to be bound by and become a party to the Limited Warranty. If you do not agree to the terms and conditions of the Limited Warranty, you should return the Product for a full refund prior to using it.

REGISTRATION

Legacy requests that you complete and return the Warranty Registration Card enclosed with the Product or register the Product at its website (www.lpc-ups.com) to establish that you are the Initial Customer of the Product, and therefore entitled coverage under the Limited Warranty. (Registration is not required for Limited Warranty coverage, but note if you do not complete a registration card you will be required to provide proof of purchase, as described below, to have the benefits of this Limited Warranty.)

LIMITED WARRANTY

Legacy warrants to you, the Initial Purchaser, that the Product will be free from defects in material and workmanship for three years from the date of original purchase, subject to the terms of this Limited Warranty. This Limited Warranty gives you specific rights, and you may have other rights, which vary from State to State or Province to Province.

Any Implied Warranty of Merchantability or for Fitness for a Particular Purpose, if applicable to the Product, is limited in duration to the period of ownership by the Initial Customer. This provision shall NOT create any Implied Warranty or Merchantability or of Fitness for a Particular Purpose that would not otherwise apply to the Product. **NOTE: Some States and Provinces do not allow limitations on how long an implied warranty lasts, so the above limitation may not apply to you.**

To be covered you must still be the owner of the Product at the time of the failure that results in the claim made under this Limited Warranty.

Exclusive Remedies Under Limited Warranty.

Your exclusive remedy and Legacys' sole obligations are as follows for the Product:

If (a) the Legacy Product you purchased and still own is defective in material or workmanship under this Limited Warranty or any applicable warranty imposed by law, and (b) all Limited Warranty requirements have been met, Legacy will repair or replace the Product if it proves to be defective in material or workmanship during the Warranty Period.

Making a Limited Warranty Claim.

To make a Limited Warranty claim on a Product, you must do the following:

1. Complete and return the Legacy Warranty Registration Card, or provide reasonable proof of purchase (for example, a sales receipt) that establishes you as the Initial Customer (the original end-user consumer purchaser) of the Product and prove that the Product was purchased within three (3) years of the event for which you want to make a claim for warranty service.
2. Call Legacy at (608) 565-5878 or (800) 859-5711 (toll free), write to Legacy Power Conversion at N9246 Hwy 80 South, Suite 7, Necedah, WI 54646, or e-mail Legacy at service@lpc-ups.com, within ten (10) days of the event for which you want to make a claim.
3. When you contact Legacy, identify the Product, the Purchase Date, and request Return Materials Authorization (RMA) information from Legacy.
4. Pack and ship the Product to Legacy as instructed in your RMA. Show the RMA code on the shipping label or include it with the Product.

You MUST prepay all shipping costs and you are responsible for packaging and shipment.

Legacy will inspect and examine the Product within ten (10) days of receipt. If the Product is not as warranted, Legacy will repair or replace the Product and return it to you at Legacy's expense, or, if Legacy is unable to or decides not to repair or replace the Product (if defective) within a reasonable time, Legacy will refund to you the full purchase price you paid for the Product (purchase receipt showing price paid is required).

CONDITIONS TO THE LIMITED WARRANTY

The Limited Warranty is the only and the exclusive express warranty of Legacy with respect to the Product. This exclusion of other express warranties applies to written and oral express warranties.

LIMITATION: THE LIMITED WARRANTY DOES NOT COVER

The Limited Warranty is intended to exclusive rights and remedies and replace any other rights, to the extent allowed by law.

As to the Legacy Product, the limited warranty **does not** cover or apply to: misuse, modification, operation or storage outside environmental limits for the Products, in transit, in shipment, or in storage, damage or deterioration, improper operation or maintenance, or use with items or equipment not designed or intended for use with the product.

The Limited Warranty Does Not Apply Unless The Initial Customer:

1. Has properly connected the Product and the Connected Equipment to properly wired and grounded outlets (including compliance with electrical and safety codes of the most current electrical code (ANS/NFPA 70), without the use of any adapters, extension cords of other connectors.
2. Has provided a suitable and proper environment for use and installation of the Product and Connected Equipment.
3. Has properly installed and operated the Legacy Product and Connected equipment.
4. Has operated the Product at all times within the limitations on the Product's VA capacity as stated in this User Manual.

Legacy Does Not Cover or Undertake Any Liability in Any Event for Any of the Following:

1. Loss of or damage to data, records, or software or the restoration of data or records, or the reinstallation of software.
2. Damage from causes other than AC Power Line Transients, spikes, or surges on properly installed, grounded and code-compliant 120 volt power lines in the United States and Canada; transients, surges or spikes on standard telephone land lines, PBX telephone equipment lines or Ethernet lines, when properly installed and connected.
3. Damage from any circumstance described as excluded above with respect to the product.
4. Damages from fire, flood, wind, rain, rising water, leakage or breakage of plumbing, abuse, misuse or alteration of either the product or the Connected Equipment.

Exclusion of Consequential and Other Damages.

The sole and exclusive remedies of the Initial Customer are those provided by the Limited Warranty. Legacy excludes any liability for personal injury under the Limited Warranty. Legacy excludes any liability for direct, indirect, special, incidental or consequential damages, whether for damage to or loss of property, loss of profits, business interruption, loss of information or data. This exclusion applies even though damage or loss is caused by negligence or other fault. NOTE: Some States or Provinces do not allow the exclusion or limitation of incidental or consequential damages, so the above limitation may not apply to you.

DO NOT USE FOR HIGH RISK ACTIVITIES.

Legacy does not sell the Products for use in high-risk activities. The Product is not designed or intended for use in hazardous environments requiring fail-safe performance, including the operation of nuclear facilities, aircraft navigation or communication systems, air traffic control, weapons systems, life support or for use in any circumstance in which the failure of the Product could lead directly to death, personal injury, or severe physical or property damage, or that would affect operation or safety of life support device (collectively, "High Risk Activities"). Legacy expressly disclaims any express or implied warranty of fitness for High Risk Activities.

Legacy does not authorize use of any of its products use in any High Risk Activities. **ANY SUCH USE IS IMPROPER AND IS A MISUSE OF LEGACY PRODUCTS.**

The Limited Warranty is governed by the laws of the United States and the State of Wisconsin, without reference to conflict of law principles.

The application of the United Nations Convention of Contracts for the International Sale of Goods is expressly excluded.

Contact Information: Legacy's address is N9246 Hwy 80 South, Necedah, WI 54646 and its phone number is (608) 565-5878 or (800) 859-5711 (toll free). Legacy is the warrantor under this Limited Warranty. You may also contact Legacy on the Internet at www.lpc-ups.com.

FCC Notice

This equipment has been tested and found to comply with the limits for a Class B Digital Device, pursuant to Part 15 of the FCC Rules. These limits are designed to provide reasonable protection against harmful interference in residential installation. This equipment generates, uses and can radiate radio frequency energy and, if not installed and used in accordance with the instructions, may cause harmful interference to radio communications. However, there is no guarantee that interference will not occur in a particular installation. If this equipment does cause harmful interference to radio or television reception, which can be determined by turning the equipment off and on, the user is encouraged to try to correct the interference by one or more of the following measures: (1) Reorient or relocate the receiving antenna. (2) Increase the separation between the equipment and receiver. (3) Connect the equipment into an outlet on a circuit different from that to which the receiver is connected. (4) Consult the dealer or an experienced radio/TV technician for help. Any special accessories needed for compliance must be specified in the instruction.

CAUTION: A shielded-type power cord is required in order to meet FCC emission limits and also to prevent interference to the nearby radio and television reception. It is essential that only the supplied power cord be used. Use only shielded cables to connect I/O devices to this equipment.

CAUTION: Any changes or modifications not expressly approved by the guarantee of this device could void the user's authority to operate the equipment.



For more information, contact us at:

Legacy Power Conversion, Inc.

N9246 Hwy 80 South, Suite 7

Necedah, WI 54646

Tel: (800) 859-5877

Fax: (608) 565-5879

Email: sales@lpc-ups.com

Web: www.lpc-ups.com

Entire contents copyright ©2006 Legacy Power Conversion, Inc.
All rights reserved. Reproduction in whole or in part without permission is prohibited.